

QuickServer Start-up Guide

FS-QS-1010/1011/12X0/12X1



APPLICABILITY & EFFECTIVITY



Effective for all systems manufactured after August 2013

Kernel Version:	6.10
Document Revision:	1

TABLE OF CONTENTS

1	Equipment Set-up	4
2	Supplied equipment	4
2.1	BTL Mark – BACnet Testing Laboratory.....	4
2.2	LonMark Certification.....	4
3	Mounting	5
3.1	Dimensions.....	5
3.1.1	<i>Dimension Drawing FS-QS-1X10-XXXX</i>	<i>5</i>
3.1.2	<i>Dimension Drawing FS-QS-1X11-XXXX</i>	<i>6</i>
3.1.3	<i>Dimension Drawing FS-QS-12XX models with RS-422</i>	<i>7</i>
3.2	Wiring.....	7
3.3	Specifications.....	8
4	Installing the QuickServer	10
4.1	RS-485	10
4.1.1	<i>RS-485 Connection R2 port.....</i>	<i>10</i>
4.1.2	<i>RS-485 Connection R1 Port (Only on Non-LonWorks QuickServers).....</i>	<i>10</i>
4.2	QuickServer LonWorks – (FS-QS-1011-XXXX or FS-QS-12X1-XXX)	11
4.3	RS-232 (Only available on the FS-QS-12XX Models).....	11
4.4	Configure the DIP Switches	11
4.4.1	<i>Using A0 – A7 to set Node ID/Device Instance.</i>	<i>12</i>
4.4.2	<i>Using B0 – B3 to set Baud Rate</i>	<i>12</i>
4.4.3	<i>DIP Switches S0-S3.....</i>	<i>12</i>
5	Operation.....	13
5.1	Power up the device.....	13
5.2	Connect the PC to the QuickServer over the Ethernet port.....	13
5.3	Use the FieldServer Web GUI to Connect to the QuickServer	14
5.3.1	<i>Using the Discovery Tool to Allocate the IP address:.....</i>	<i>14</i>
5.4	Set IP Address of the QuickServer	15
6	Configuring the QuickServer.....	16
6.1	Retrieve the Sample Configuration File.....	16
6.2	Change the Configuration File to Meet the Application	16
6.3	Load the Updated Configuration file.....	17
6.4	Test and Commission the QuickServer.....	18
Appendix A	Useful Features.....	19
Appendix A.1.	QuickServer DIP Switch configuration	19
Appendix A.1.1.	<i>Configure DIP switches A0-A7</i>	<i>19</i>
Appendix A.1.2.	<i>Configure DIP switches B0 – B3.....</i>	<i>19</i>
Appendix A.1.3.	<i>Configure DIP switches S0 – S3</i>	<i>20</i>
Appendix A.2.	RS-422 (Only available on the FS-QS-12XX models)	21
Appendix A.2.1.	<i>Connection and Operation of the RS-422 QuickServer.....</i>	<i>22</i>
Appendix A.3.	KNX	22
Appendix A.4.	Enhanced Network Security.....	23
Appendix B	Troubleshooting Tips.....	24
Appendix B.1.	Communicating with the QuickServer over the Network.....	24

Appendix B.2. Technical support.....	24
Appendix B.3. Notes Regarding Subnets and Subnet Masks	24
Appendix C Limited 2 year Warranty	25
Appendix D Reference	26
Appendix D.1. FS-QS-1010-XXXX LED's	26
<i>Appendix D.1.1. LED Functions</i>	<i>26</i>
Appendix D.2. FS-QS-1011-XXXX LED's	27
Appendix D.3. QuickServer FS-QS-101X DCC	28
Appendix D.4. Compliance with UL Regulations	28
Appendix D.5. Address DIP Switch Settings	29
Appendix D.6. Baud DIP Switch Settings	35

1 EQUIPMENT SET-UP¹

QuickServer is a high performance, cost effective Building and Industrial Automation multi-protocol gateway providing protocol translation between serial, Ethernet, and LonWorks devices and networks.

2 SUPPLIED EQUIPMENT

QuickServer Gateway.

- Preloaded with the two selected drivers (on the FS-QS-1X11 and FS-QS-12X1 one of those drivers is LonWorks). A sample configuration file is also pre-loaded onto the QuickServer.
- All instruction manuals, driver manuals, configuration manuals and support utilities are available on the USB drive provided in the optional accessory kit, or on-line at www.fieldserver.com/QS_Support/

Accessory kit (Optional) (Part # FS-8915-36-QS) including:

- 7-ft CAT5 cable with RJ45 connectors at both ends
- Power Supply -110/220V (p/n 69196)
- DIN Rail mounting bracket
- Screwdriver for connecting to terminals
- USB Flash drive loaded with:
 - QuickServer Start-up Guide
 - FieldServer Configuration Manual
 - FieldServer Utilities Manual
 - All FieldServer Driver Manuals
 - Support Utilities
 - Any additional folders related to special files configured for a specific QuickServer
 - Additional components as required - See Driver Manual Supplement for details



2.1 BTL Mark – BACnet Testing Laboratory



The BTL Mark on the ProtoNode RER is a symbol that indicates to a consumer that a product has passed a series of rigorous tests conducted by an independent laboratory which verifies that the product correctly implements the BACnet features claimed in the listing. The mark is a symbol of a high-quality BACnet product. For more information about the BACnet Testing Laboratory go to: <http://www.bacnetinternational.net/btl/>

2.2 LonMark Certification



LonMark International is the recognized authority for certification, education, and promotion of interoperability standards for the benefit of manufacturers, integrators and end users. LonMark International has developed extensive product certification standards and tests to provide the integrator and user with confidence that products from multiple manufacturers utilizing LonMark devices will work together. FieldServer Technologies, manufacturer of the QuickServer has more LonMark Certified gateways than any other gateway manufacturer.

¹ LonWorks is a registered trademark of Echelon Corporation
Metasys is a registered trademark of Johnson Controls Inc.
BACnet is a registered trademark of ASHRAE

3 MOUNTING

The following mounting options are available:

- Product comes with tabs for wall or surface mount. These can be snapped off if not required.
- DIN Rail Mounting Bracket - included in the Accessory Kit or ordered separately (Part # FS-8915-35-QS)



3.1 Dimensions

3.1.1 Dimension Drawing FS-QS-1X10-XXXX

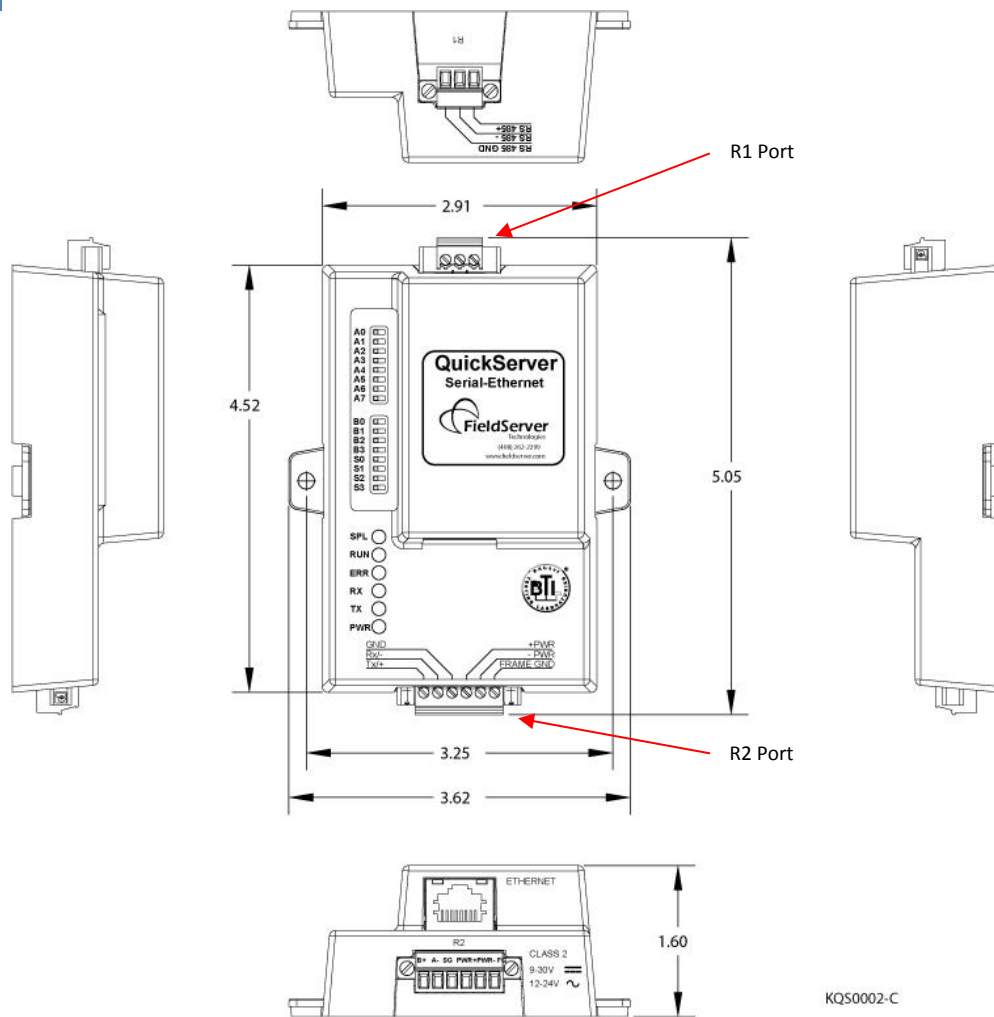

3.1.2 Dimension Drawing FS-QS-1X11-XXXX

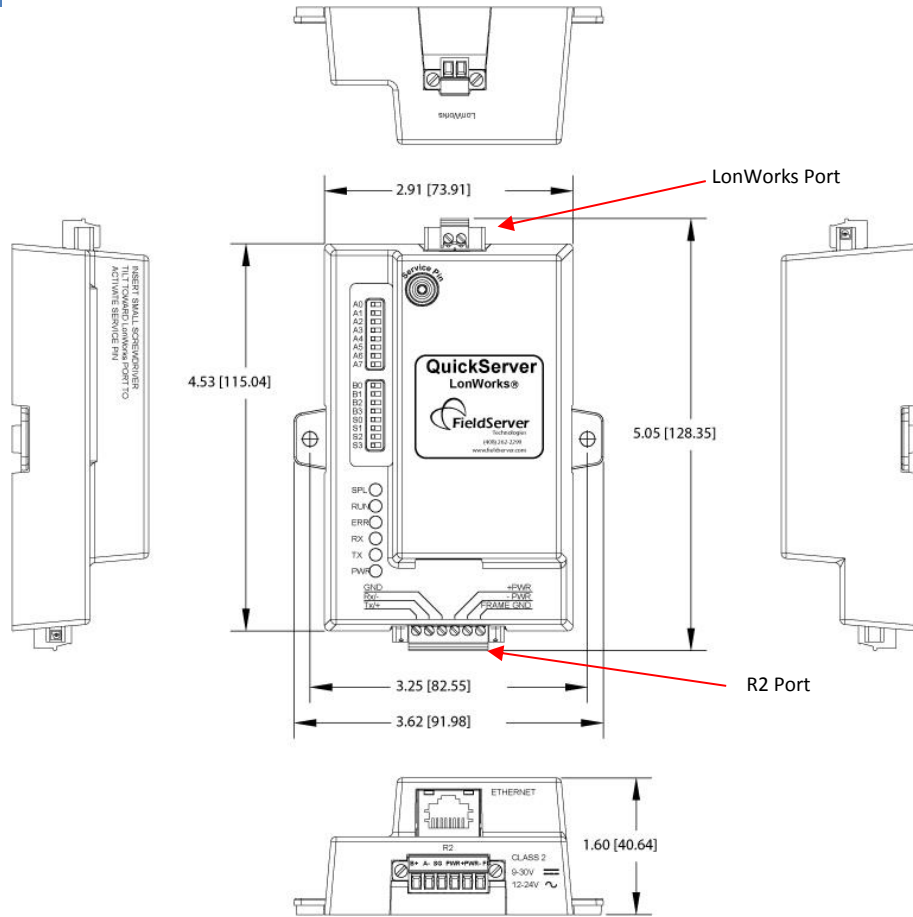

3.1.3 Dimension Drawing FS-QS-12XX models with RS-422

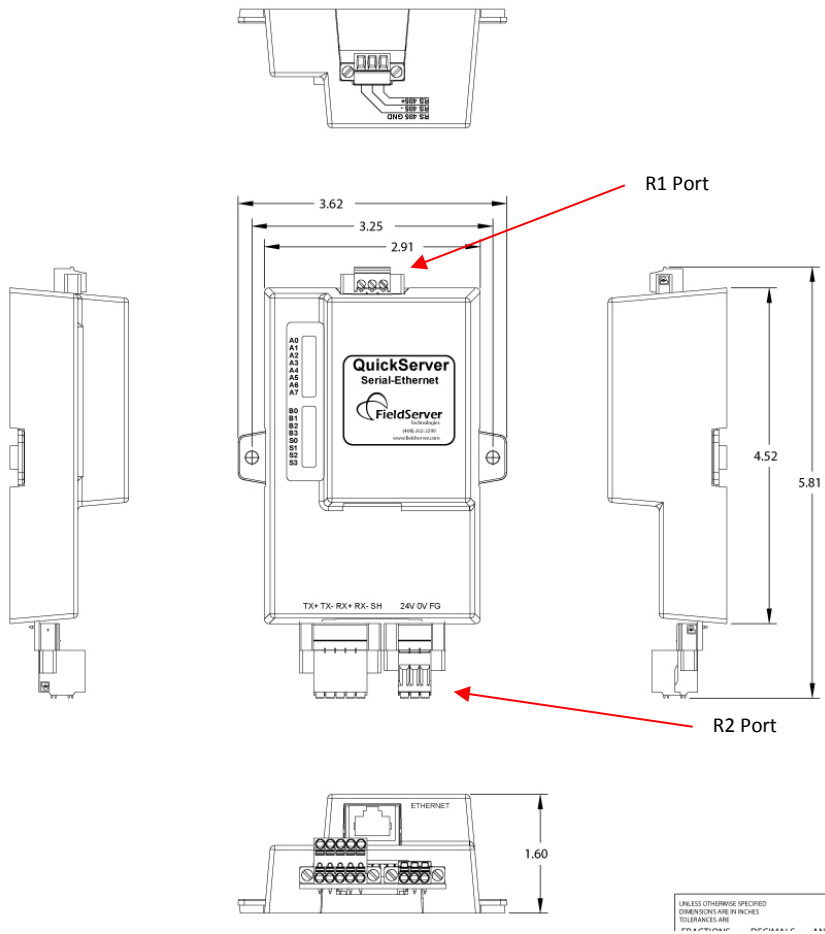

3.2 Wiring

Power supply must be connected to the terminal block.

3.3 Specifications²

	FS-QS-1010-XXXX & FS-QS-12X0-XXXX ³	FS-QS-1011-XXXX & FS-QS-12X1-XXXX
Available Ports	One 6-pin Phoenix connector, one RS-485 +/- ground port, power +/- frame ground port One 3-pin RS-485 Phoenix connector, one RS-485 +/- ground port One Ethernet-10/100 port	One 6-pin Phoenix connector, one RS-485 (or RS-232 or RS-422) +/- ground port, power +/- frame ground port 2-pin FTT-10 LonWorks port One Ethernet-10/100 port
Power Requirements	Input Voltage: 9-30VDC or 12-24VAC Input Power Frequency 50/60 Hz. Power Rating: 2.5 Watts Current draw @ 12V, 150 mA	Input Voltage: 9-30VDC or 12-24VAC Input Power Frequency 50/60 Hz. Power Rating: 2.5 Watts Current draw @ 12V, 279 mA
Approvals	TUV approved to UL 916 Standard RoHS Compliant FCC Part 15 Compliant DNP compliant OPC self-tested to conformance CE Mark BTL Mark	TUV approved to UL 916 Standard RoHS Compliant FCC Part 15 Compliant DNP compliant OPC self-tested to conformance LonMark Certification SPID: 80:00:95:46:00:84:04:01 Profiles: 0000 - Node object (1) 0001 - Open Loop Sensor Object (5) 0003 - Open Loop Actuator Object (5)
Surge Suppression		
EN61000-4-2 ESD EN61000-4-3 EMC EN61000-4-4 EFT		
Physical Dimensions(excluding the external power supply)		
(WxDxH):	5.05 x 2.91 x 1.6 in. (12.82 x 7.39 x 4.06 cm) excluding mounting tabs	
Weight:	0.4 lbs (0.2 Kg)	
Environment:		
Operating Temperature:	-40°C to 75°C (-40°F to 167°F)	
Humidity:	5 - 90% RH (non-condensing)	

“This device complies with part 15 of the FCC Rules. Operation is subject to the following two conditions:

- This device may not cause harmful interference
- This device must accept any interference received, including interference that may cause undesired operation.

² Specifications subject to change without notice

³ XXXX at the end of the part number identifies the code for the specific drivers included in the QuickServer. Refer to Appendix D.3

Note: This equipment has been tested and found to comply with the limits for a Class A digital device, pursuant to part 15 of the FCC Rules. These limits are designed to provide reasonable protection against harmful interference when the equipment is operated in a commercial environment. This equipment generates, uses, and can radiate radio frequency energy and, if not installed and used in accordance with the instruction manual, may cause harmful interference to radio communications. Operation of this equipment in a residential area is likely to cause harmful interference in which case the user will be required to correct the interference at his expense. Modifications not expressly approved by FieldServer could void the user's authority to operate the equipment under FCC rules”

4 INSTALLING THE QUICKSERVER

4.1 RS-485

4.1.1 RS-485 Connection R2 port



Connect to the 3 pins on the left-hand-side of the 6 pin connector as shown.

The following Baud Rates are supported on the R2 Port:

4800, 9600, 19200, 38400, 57600, 115200

Refer to Appendix D.6 for the Dip Switch Settings for these Baud Rates.

For connection to RS-232 or RS-422, please refer to Appendix A.2

4.1.2 RS-485 Connection R1 Port (Only on Non-LonWorks QuickServers)

Connect to the 3-pin connector as shown.



The following Baud Rates are supported on the R1 Port:

110, 300, 600, 1200, 2400, 4800, 9600, 19200, 20833, 28800, 38400, 57600, 76800, 115200

Refer to Appendix D.6 for the Dip Switch Settings for these Baud Rates.

4.2 QuickServer LonWorks – (FS-QS-1011-XXXX or FS-QS-12X1-XXX)

Connect the QuickServer to the LonWorks terminal using a twisted pair non-shielded cable.



To commission the QuickServer LonWorks port, insert a small screwdriver in the commissioning hole on the face of the QuickServer's enclosure to access the Service Pin. See the instructions on the QuickServer as to which way to toggle the screwdriver during commissioning.

4.3 RS-232 Connection R2 Port (Only available on the FS-QS-12XX Models)

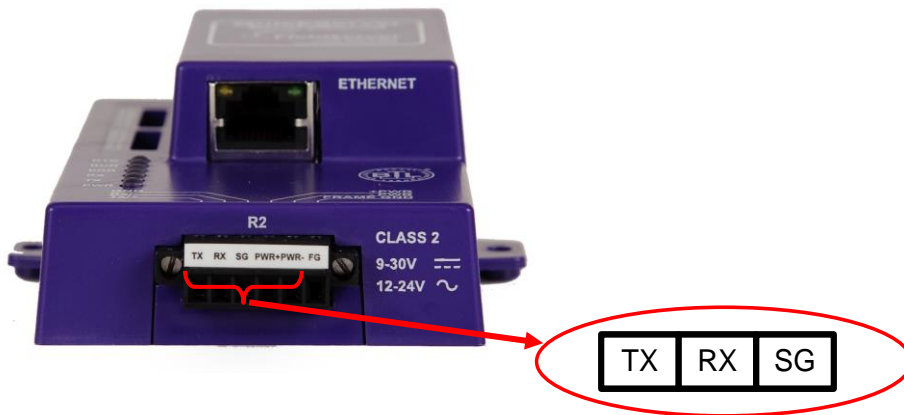

Refer to Appendix A2 for further hardware connection options.

The following Baud Rates are supported on the R2 Port:

4800, 9600, 19200, 38400, 57600, 115200

Refer to Appendix D.6 for the Dip Switch Settings for these Baud Rates

4.4 Configure the DIP Switches

The DIP switches on the QuickServer allow users to set the Baud Rate, Node-ID, and MAC address. If a custom configuration has been purchased, these DIP switches will have been configured at the factory. If doing a self-configuration, each of these DIP switches will have to be configured. Although it is technically possible to configure the DIP switches in a variety of ways, it is recommended that the banks are configured as laid out in this manual. It is necessary to restart the QuickServer in order for the DIP switch changes to take effect.

4.4.1 Using A0 – A7 to set Node ID/Device Instance.

Refer to Appendix A.1 for configuration example.

The A bank can set the Node-ID/Device Instance for any protocol which requires one.

DIP switches A0 – A7 can be also be used to set MAC Address for BACnet MS/TP. See the DIP switch settings for the full range of addresses in Appendix D.5

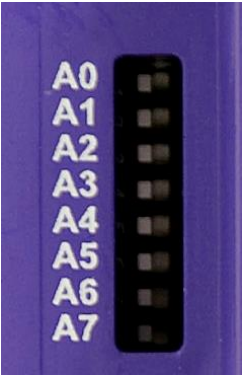
	Address	1	...	128	...	255
	A0	On	.	Off	.	On
	A1	Off	.	Off	.	On
	A2	Off	.	Off	.	On
	A3	Off	.	Off	.	On
	A4	Off	.	Off	.	On
	A5	Off	.	Off	.	On
	A6	Off	.	Off	.	On
	A7	Off	.	On	.	On

4.4.2 Using B0 – B3 to set Baud Rate

Refer to Appendix A.1 for configuration example. The DIP switches B0 – B3 can be set for standard Baud Rates between 110 and 115200 Baud. Refer to Appendix D.6 for DIP switch settings.

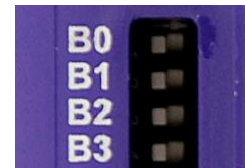

4.4.3 DIP Switches S0-S3

Refer to Appendix A.1 and Appendix A.1.3 for configuration example. The S0 - S3 DIP switch selection is read directly into a Data Array. This Data_Array value can be used for customized operations such as configuration selection.



5 OPERATION

5.1 Power up the device

Apply power to the device. Ensure that the power supply used complies with the specifications provided in. Ensure that the cable is grounded using the "Frame GND" terminal. The QuickServer is factory set for 9-30VDC or 12-24VAC.

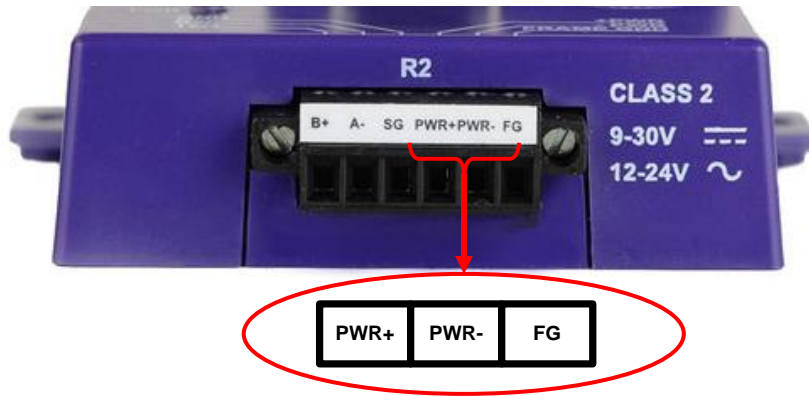

5.2 Connect the PC to the QuickServer over the Ethernet port.

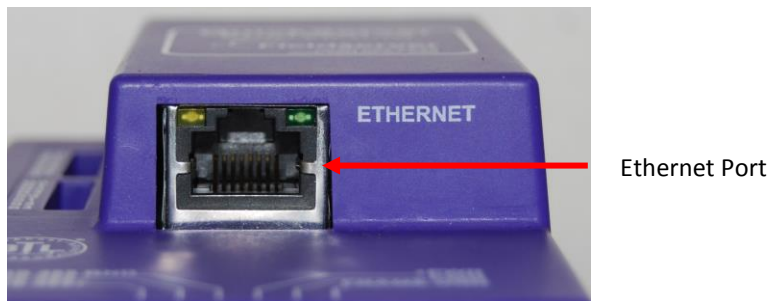

- Disable any wireless Ethernet adapters on the PC/Laptop.
- Disable firewall and virus protection software .
- Connect an Ethernet cable between the PC and QuickServer or connect the QuickServer and the PC to the Hub/switch using a straight cat5 cable.
- The Default IP Address of the QuickServer is **192.168.2.X**, Subnet Mask is **255.255.255.0**. If the PC and the QuickServer are on different IP Networks, assign a Static IP Address to the PC on the 192.168.2.X network.

5.3 Use the FieldServer Web GUI to Connect to the QuickServer

5.3.1 Using the Discovery Tool to Allocate the IP address:

- Install the Discovery tool from the USB drive or get it from our website
<http://fieldserver.com/techsupport/utility/utility.php>
- Use the Discovery tool to find the QuickServer, and launch the Web GUI from the Discovery tool

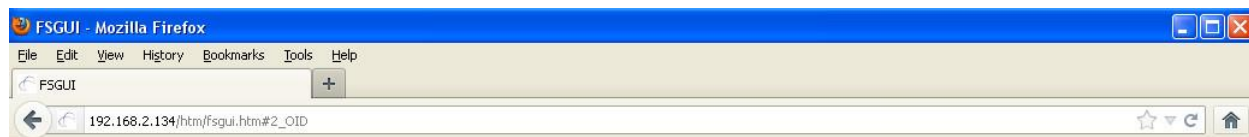

Name	Value
Driver_Configuration	DCC285
PCC_Version	V6.04u (A)
Kernel_Version	V6.06i (B)
Release_Status	Normal
Bootloader_Version	V1.00b (A)
BSP_Version	V1.00e (B)
FieldServer_Model	FS-QS-1010
Flash_Size	4M
Data_Points_Used	6
Data_Points_Max	250
Application Memory:	
Memory_Percent_Used	7.60%
Memory_Used	260 kB
Memory_Available	3,427 kB
Avg_Cycle_Time	3

5.4 Set IP Address of the QuickServer

- From the GUI main home page, click on setup and then Network Settings to enter the Edit IP Address Settings menu.
- Modify the IP address (N1 IP address field) of the QuickServer Ethernet port.
- If necessary, change the Netmask (N1 Netmask field).
- Type in a new Subnet Mask
- If necessary, change the IP Gateway (Default Gateway field)
- Type in a new IP Gateway
- Note: If the FieldServer is connected to a router, the IP Gateway of the FieldServer should be set to the IP address of the router that it is connected to
- Click Update IP Settings, then click on the System Restart to restart the Gateway and activate the new IP address. Note that the QuickServer will need to be pointed to the new IP address on the Web Browser before the GUI will be accessible again. Unplug Ethernet cable from PC and connect it to the network hub or router

The screenshot shows the FSGUI web interface in Mozilla Firefox. The browser's address bar displays the URL `192.168.2.134/htm/fsgui.htm#22_OID`. The interface features a navigation tree on the left with the following items: DCC285 QS.CSV v4.10b, About, Setup, File Transfer, Network Settings (highlighted), View, and User Messages. The main content area is titled "Network Settings" and includes a "Note" box stating: "Updated settings only take effect after a System Restart. If the IP Address is changed you will need to direct your browser to the new IP Address after the System Restart." Below the note, there are several configuration fields: "N1 IP Address" (192.168.2.134), "N1 Netmask" (255.255.255.0), "N1 DHCP Client State" (ENABLED), "N1 DHCP Server State" (DISABLED), and "Default Gateway" (192.168.2.1). At the bottom of the settings area are "Cancel" and "Update IP Settings" buttons. At the very bottom of the interface are "HELP (F1)" and "System Restart" buttons.

6 CONFIGURING THE QUICKSERVER

6.1 Retrieve the Sample Configuration File

The configuration of the QuickServer is provided to the QuickServer's operating system via a comma-delimited file called "CONFIG.CSV".

If a custom configuration was ordered, the QuickServer will be programmed with the relevant device registers in the Config.csv file for the first time start-up. If not, the product is shipped with a sample config.csv that shows an example of the drivers ordered.

- In the main menu of the FS-GUI screen, go to Setup, File Transfer, Retrieve.
- Click on config.csv, and open or save the file

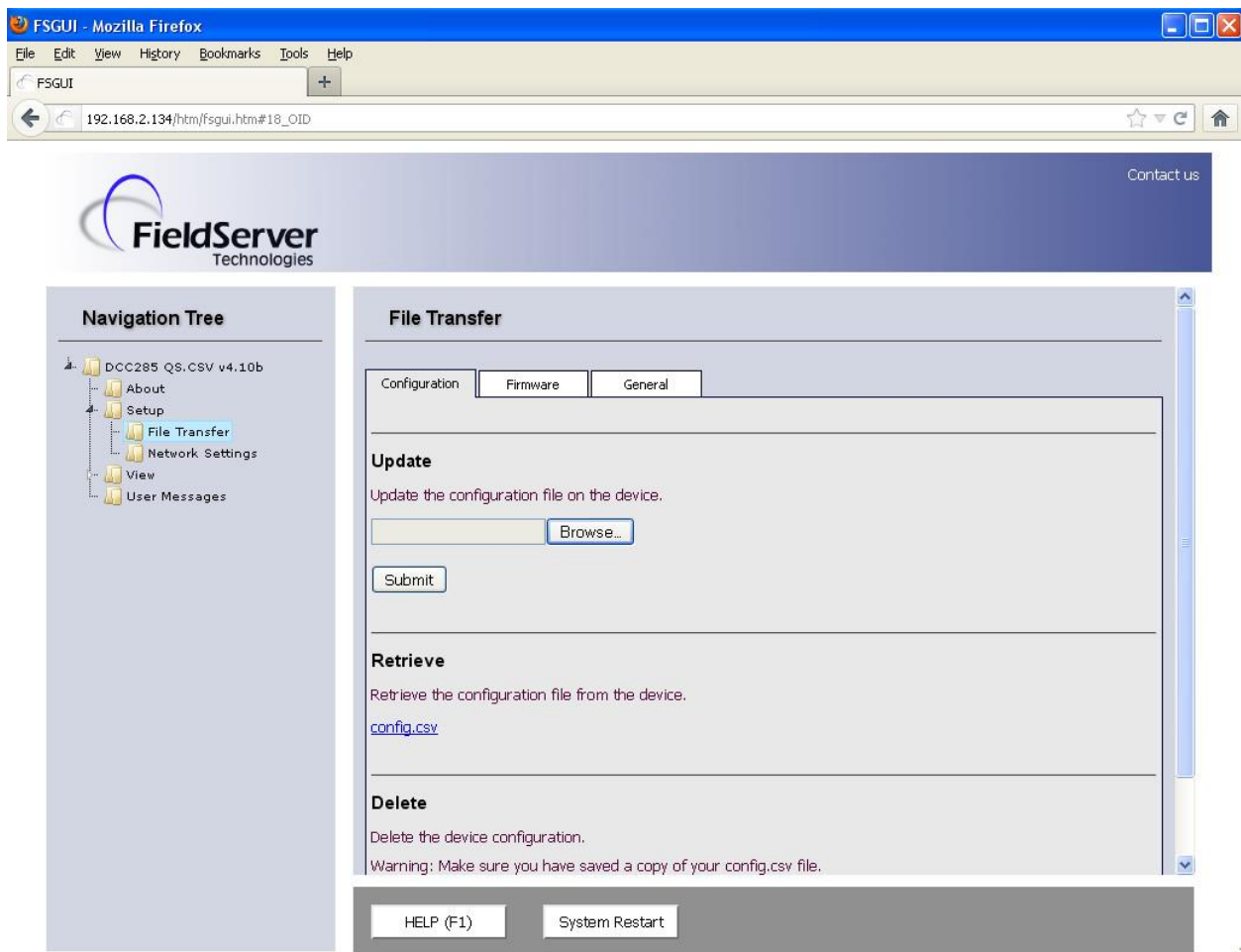

6.2 Change the Configuration File to Meet the Application

Refer to the FieldServer Configuration Manual in conjunction with the Driver supplements for information on configuring the QuickServer.

6.3 Load the Updated Configuration file

- In the main menu of the FS-GUI screen, go to Setup, File Transfer, Update
- Browse and select the .csv file, open, then click Submit

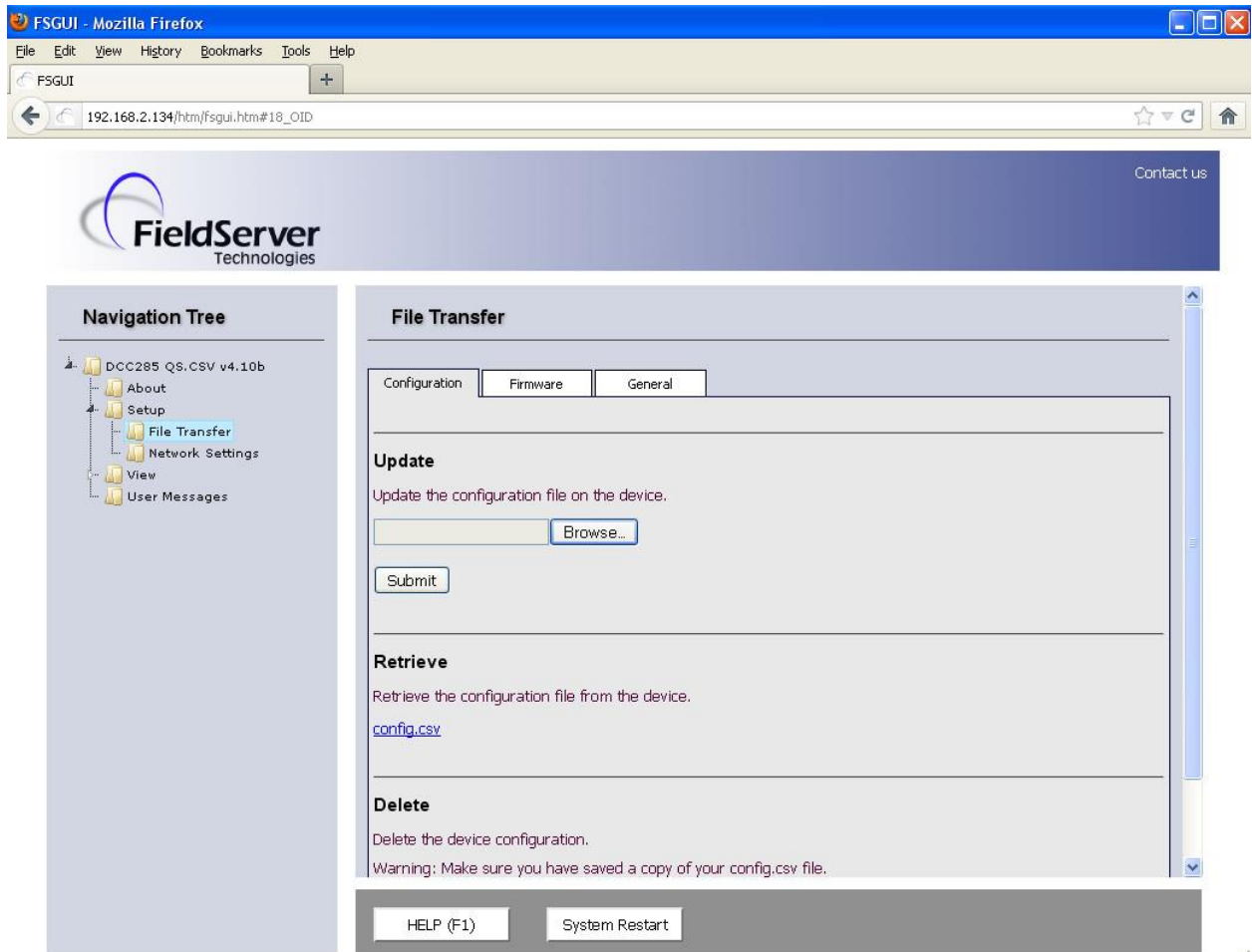

- Once download is complete, click the System Restart Button (or simply cycle power to the QuickServer) to put the new file into operation. Note that it is possible to do multiple downloads to the QuickServer before resetting it.

6.4 Test and Commission the QuickServer

- Connect the QuickServer to the third party device(s), and test the application.
- From the main menu of FS-GUI click on View, Connections to see the number of messages on each protocol.

Configuration update complete. Please restart the system to load the new Configuration.

FieldServer Technologies

Navigation Tree

- DCC285 QS.CSV v4.10b
 - About
 - Setup
 - File Transfer
 - Network Settings
 - View
 - Connections**
 - R1 - BACnet_MSTP
 - N1 - BACnet_IP
 - Data Arrays
 - Nodes
 - Map Descriptors
 - User Messages

Connections

Overview

Connections						
Index	Name	Tx Msg	Rx Msg	Tx Char	Rx Char	Errors
0	R1 - BACnet_MSTP	7,321	0	43,926	0	32,940
1	N1 - BACnet_IP	0	0	0	0	0

HELP (F1) Reset Statistics

- For troubleshooting assistance refer to Appendix B, or any of the troubleshooting Appendices in the related Driver Supplements and Configuration Manual. FieldServer Technologies also offers a Technical support page on the FieldServer website at www.FieldServer.com, which contains a significant number of resources and documentation that may be of assistance.

Appendix A Useful Features

Appendix A.1. QuickServer DIP Switch configuration

There are 3 DIP switches available on the QuickServer.

- A – Address DIP Switch
- B – Baud rate DIP Switch
- S – Secondary DIP Switch

The following sections describe how to set up the DIP switches in the configuration file. To configure the use of the DIP switches, buffers need to be declared in the “Data Arrays” section which will enable them.

Data_Arrays				
Data_Array_Name	Data_Format	Data_Array_Length	Data_Array_Function	Scan_Interval
DA_A	, UINT16	, 1	, Dip_Switches_A	, 2s
DA_B	, BAUD	, 1	, Dip_Switches_B	, 2s
DA_S	, UINT16	, 1	, Dip_Switches_S	, 2s

Appendix A.1.1. Configure DIP switches A0-A7

To configure DIP switches A0-A7 to adjust the Device Id, BACnet MAC address, or both, the dynamic parameters field needs to be added to the configuration file.

Dynamic_Parameters					
Function	Data_Array_Name	Data_Array_Offset	Descriptor_Name	Low_Limit	High_Limit
Change_Node_ID	, DA_A	, 0	, Node_Name_A	, 1	, 4194303
Change_System_MAC_Addr	, DA_A	, 0	, Title_A	, 1	, 254

Appendix A.1.2. Configure DIP switches B0 – B3

To configure DIP switches B0-B3 to adjust the baud rate, the dynamic parameters field needs to be added to the configuration file.

Dynamic_Parameters			
Function	Data_Array_Name	Data_Array_Offset	Descriptor_Name
Baud_Rate	, DA_BAUD	, 0	, P1

Appendix A.1.3. Configure DIP switches S0 – S3

The S0 - S3 DIP switch selection is read directly into a Data Array. This Data Array value can be used for customized operations such as config file selection which allows a FieldServer to be loaded with several configurations / profiles that are selected based on a Data Array value. See the example below where a Config Table and Dynamic Parameter can be used in conjunction with the DIP Switches to achieve this type of customization. .

In this example, 5 configs will need to be downloaded to the QuickServer: config.csv (base config), profile1.csv, profile2.csv, profile3.csv and profile4.csv. The profile configs will be configured as per FieldServer standard configuration templates. The base config will be used to select the appropriate profile config to load.

Column Title	Function	Legal Values
Config_Table_Name	Provide name for Config Table	Up to 32 alphanumeric characters
Table_Index_Value	A unique value that will be used to identify which table entry needs to be used.	
Table_String	A String value, representing the filename of the profile to be loaded for the corresponding Table_Index_Value.	1-10,000
Restart_Method*	The specified config or profile is loaded on start-up. If the parameter is configured as On_Change, the QuickServer will restart and reload the specified config every time the Data_Array value changes. Otherwise the config or profile will remain unchanged even if the Data_Array value changes.	On_Change, Never, _

Data_Arrays				
Data_Array_Name	Data_Format	Data_Array_Length	Data_Array_Function	Scan_Interval
DA_LOAD_CSV	UINT16	1	Dip_Switches_S	2s

Config_Table				
Config_Table_Name	Table_String	Table_Index_Value		
csvfilenames	profile1.csv	1	// Profile config 1	
csvfilenames	profile2.csv	2	// Profile config 2	
csvfilenames	profile3.csv	3	// Profile config 3	
csvfilenames	profile4.csv	4	// Profile config 4	

Dynamic_Parameters				
Function	Data_Array_Name	Data_Array_Offset	Config_Table_Name	Restart_Method
load_csv	DA_LOAD_CSV	2	csvfilenames	On_Change

Note: In this example the value 0 has no operation, so if 0 is read on the dip switches no profile will be loaded. Similarly values larger than 4 will be ignored.

Appendix A.2. RS-422 Connection R2 Port (Only available on the FS-QS-12XX models)

RS422 is a full duplex multi-drop multi-master differential bus. It can be wired to conform to a RS-485 network when less wiring/cabling is used (due to being less expensive to install), but then it becomes a half-duplex multi-drop multi-master differential bus. RS-422 is used for dedicated peer to peer high speed communication when low bus latency is required i.e. very few devices on the bus. Its usage is very specific to client installations/requirements.

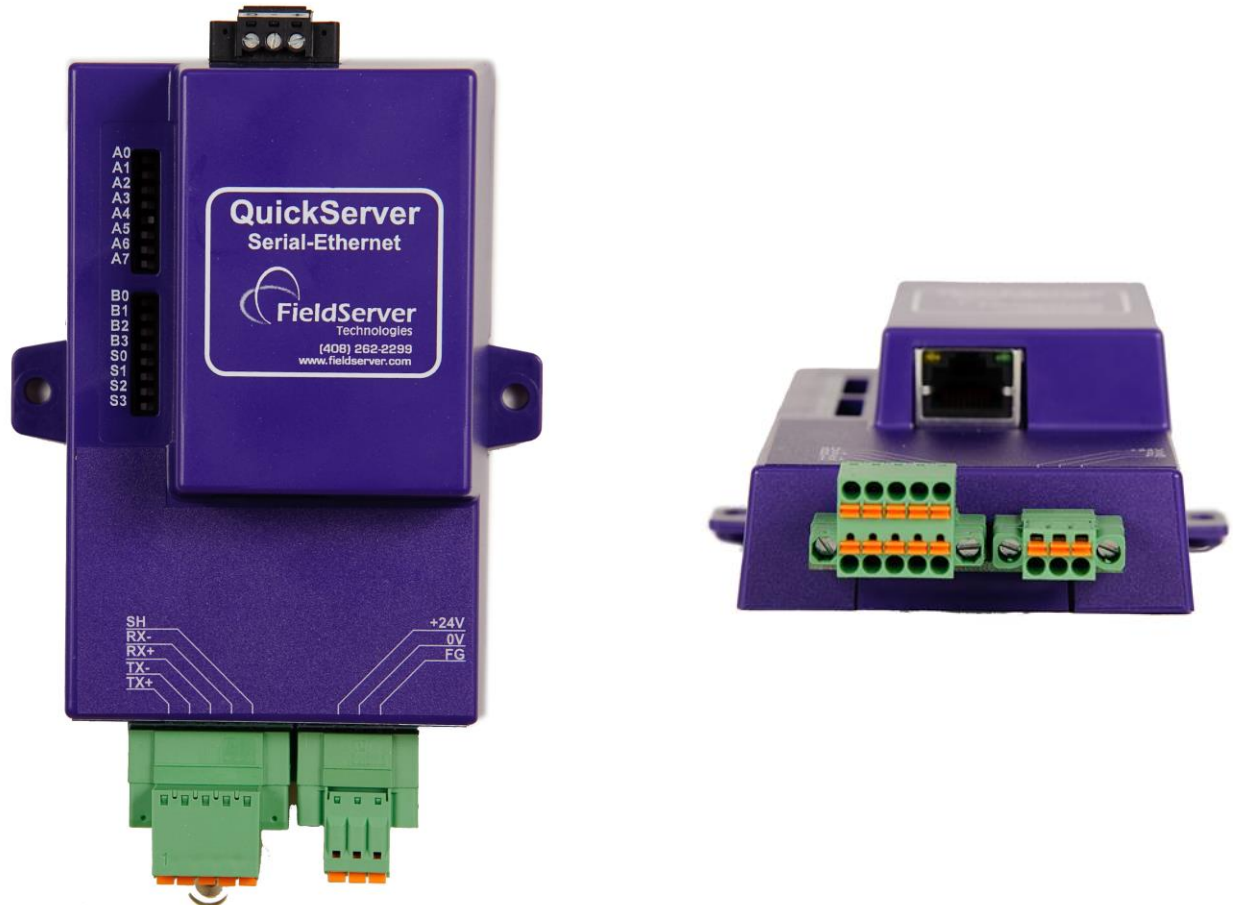

Notes:

- The RS-232 looks similar to the RS-485 but does not have the blue jumper. The blue jumper is used to enable the termination resistor for the RX signals (120 ohms), while the red jumpers are used to enable the bias resistors for RX signals (510 ohms). In the case of Rockwell/Tetrapak, all jumpers are always required to be in default position i.e. not enabled. For other clients, the bias resistors should always be in the on state.
- The Part number on the back of the box will identify the port..

Appendix A.2.1. Connection and Operation of the RS-422 QuickServer

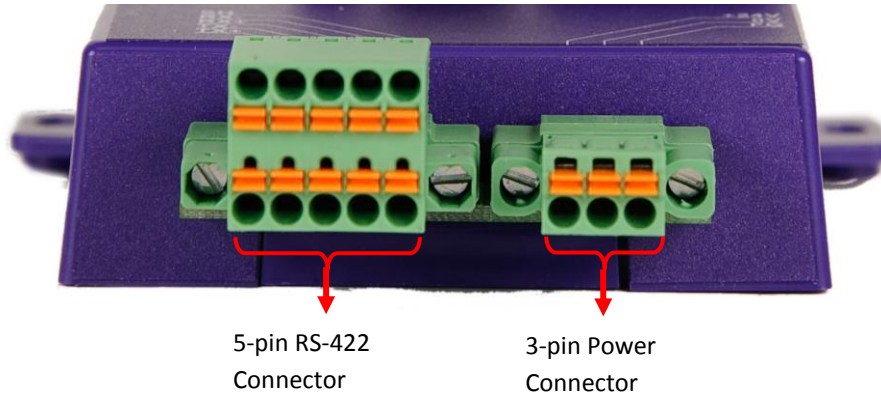
**RS422 connector:**

Pin 1-2: TX +/- (Differential TX outputs: All + signals must be connected to each other, and same applies to - signals; no +/- signals may be crossed)

Pin 3-4: RX +/- (Differential RX inputs: All + signals must be connected to each other, and same applies to - signals, no +/- signals may be crossed)

Pin 5: SHD (Shield connection, must be connected on at least one side of the bus, but not necessarily on both sides)

POWER connector:

Please note that AC voltage is not supported on the RS-422 Carrier, and that DC voltage range is ~20VDC to ~28VDC.

Pin 1: +24V (DC power requires this pin be used for the positive voltage)

Pin 2: 0V (DC power requires this pin is used for ground / return voltage)

Pin 3: FG (This pin needs to be connected to EARTH or noise free reference point i.e. CHASSIS)

Appendix A.3. KNX Connection R2 Port

The KNX QuickServer is used to transfer data to and from devices using KNX protocol. The KNX driver enables data access from KNX networks to other FieldServer protocols. Most KNX data-point types are supported, allowing communication to almost any kind of KNX device in an installation, such as temperature sensors, shutters, light switches, actuators, alarms, etc. This allows BMS systems to access a KNX network using direct read and write or with KNX configured groups. This setup does not require the use of ETS4 to configure the QuickServer KNX gateway. The KNX protocol is a connectionless protocol and therefore supports multiple clients and multiple servers. The QuickServer is intended to act as a Passive Client on the KNX bus and make information available to other protocols.



The KNX Connection consist of a KNX + and KNX- terminal. Each terminal corresponds to the red KNX+ and gray KNX- bus connections on a KNX bus.

The following Baud Rates are supported on the R2 Port:
4800, 9600, 19200, 38400, 57600, 115200

Appendix A.4. Enhanced Network Security

For enhanced network security, one can disable RuiNet access to a FS-GUI capable FieldServer by use of the RUI_Enable FieldServer parameter. Adding the following to the configuration file will disable RuiNet Access.

```
FieldServer
Title           , RUI_Enable
FieldServer Name , Disabled // Enabled -- is the default if not specified
```

Note: In order to take a FieldServer Diagnostics log, RuiNet access has to be enabled again.

Appendix B Troubleshooting Tips

Appendix B.1. Communicating with the QuickServer over the Network

- Confirm that the network cabling is correct.
- Confirm that the computer network card is operational and correctly configured.
- Confirm that there is an Ethernet adapter installed in the PC's Device Manager List, and that it is configured to run the TCP/IP protocol.
- Check that the IP netmask of the PC matches the QuickServer. The Default IP Address of the QuickServer is 192.168.2.X, Subnet Mask is 255.255.255.0.
 - Go to Start|Run
 - Type in "ipconfig"
 - The account settings should be displayed.
 - Ensure that the IP address is 102.168.2.X and the netmask 255.255.255.0
- Ensure that the PC and QuickServer are on the same IP Network, or assign a Static IP Address to the PC on the 192.168.2.0 network.
- If using Windows XP or later, ensure that the firewall is disabled.
- Ensure that all other Ethernet cards active on the PC, especially wireless adapters are disabled.
- Refer to the FieldServer Troubleshooting Guide which can be found at www.fieldserver.com/QS_Support/ for further information

Appendix B.2. Technical support

Before contacting Technical support to report an issue, go to Start|Programs|FieldServer utilities|Tools and run the FST_Diag program. Take a log (See ENote0058 in the folder called Library on the USB Flash Drive). Send this log together with a detailed description of the problem to support@fieldserver.com for evaluation.

Note that while all necessary documentation is shipped with the FieldServer on the USB flash drive, these documents are constantly being updated. Newer versions may be available on the web at www.fieldserver.com/QS_Support/

Appendix B.3. Notes Regarding Subnets and Subnet Masks

Please Note that RFC standards allocate the IP address range of 192.0.0.0 through to 223.255.255.255 to be used in Class-C subnetting (i.e.: Subnets listed as 255.255.255.xxx, where xxx can vary based on filtering required).

Consequently, the IP stack for this product will not allow any IP addresses in this range to be allocated a subnet that does not fall within the Class C range.

Appendix C Limited 2 year Warranty

FieldServer Technologies warrants its products to be free from defects in workmanship or material under normal use and service for two years after date of shipment. FieldServer Technologies will repair or replace any equipment found to be defective during the warranty period. Final determination of the nature and responsibility for defective or damaged equipment will be made by FieldServer Technologies personnel.

All warranties hereunder are contingent upon proper use in the application for which the product was intended and do not cover products which have been modified or repaired without FieldServer Technologies approval or which have been subjected to accident, improper maintenance, installation or application, or on which original identification marks have been removed or altered. This Limited Warranty also will not apply to interconnecting cables or wires, consumables or to any damage resulting from battery leakage.

In all cases FieldServer Technology's responsibility and liability under this warranty shall be limited to the cost of the equipment. The purchaser must obtain shipping instructions for the prepaid return of any item under this warranty provision and compliance with such instruction shall be a condition of this warranty.

Except for the express warranty stated above, FieldServer Technologies disclaims all warranties with regard to the products sold hereunder including all implied warranties of merchantability and fitness and the express warranties stated herein are in lieu of all obligations or liabilities on the part of FieldServer Technologies for damages including, but not limited to, consequential damages arising out of/or in connection with the use or performance of the product.

Appendix D Reference

Appendix D.1. FS-QS-1010-XXXX LED's

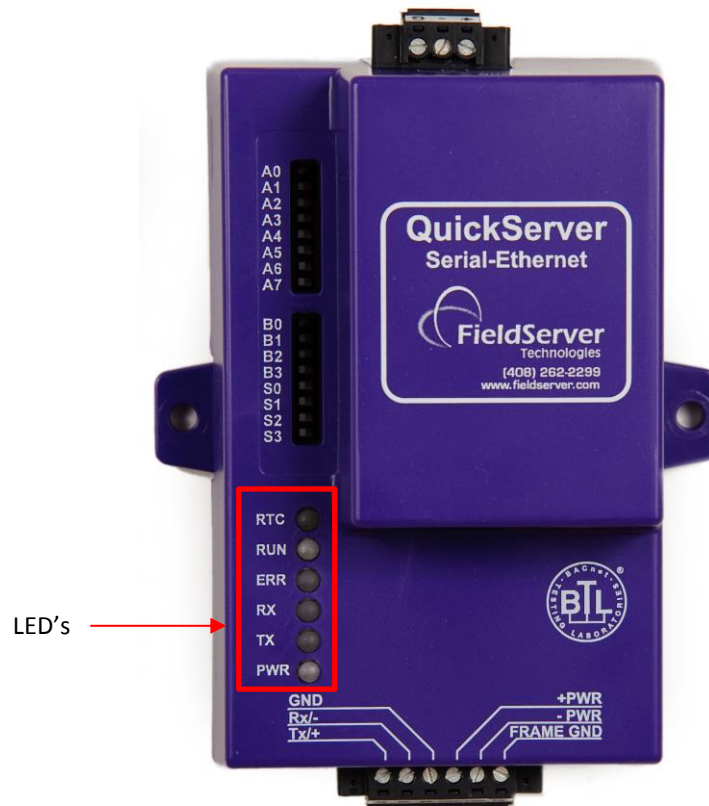

Appendix D.1.1. LED Functions

Light	Description
RTC	To Be Determined
RUN	RUN LED will flash 20 seconds after power up, signifying normal operation. The QuickServer will be able to access FS-GUI (refer to Section 5.3 for more information) once this LED starts flashing. During the first 20 seconds, the LED should be off
ERR	The ERR LED will go on solid 15 seconds after power up. It will turn off after 5 seconds. A steady red light will indicate there is a system error on the FieldServer. If this occurs, immediately report the related "system error" shown in the error screen of the FS-GUI interface to FieldServer Technologies for evaluation.
RX	On normal operation of FS-QS-1010, the RX LED will flash when a message is received on the field port of the QuickServer.
TX	On normal operation of FS-QS-1010, the TX LED will flash when a message is sent on the field port of the QuickServer
PWR	This is the power light and should show steady green at all times when the QuickServer is powered.

Appendix D.2. FS-QS-1011-XXXX LED's

Note that the lid on top of the QuickServer has to be removed in order to see the LED's

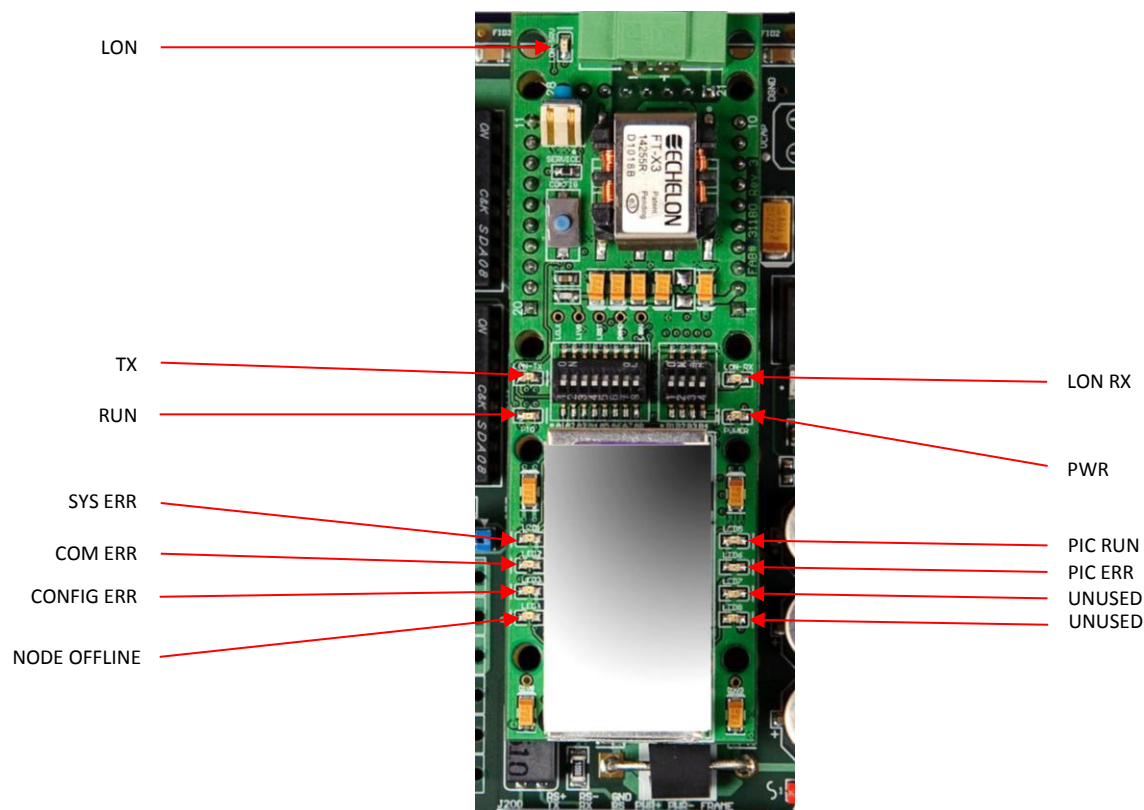

Light	Description
PWR	This is the power light and should show steady green at all times when the FS-QS-1011-XXXX is powered.
SYS ERR (LED1)	The SYS ERR LED will flash once on power up and flash once 15 seconds after power up. A steady red light will indicate there is a system error on the FS-QS-1011-XXXX. If this occurs, immediately report the related "system error" shown in the error screen of the FS_GUI interface to FieldServer Technologies for evaluation.
COMM ERR (LED2)	The COMM ERR LED will flash once on power up and flash once 15 seconds after power up. A steady red light will indicate a communication error has occurred. To establish the cause of the error, go to the error screen of the RUI interface.
Config ERR (LED3)	The Config ERR LED will flash once on power up and flash once 15 seconds after power up. A steady amber light will indicate a configuration error exists in the active configuration. See the Error Screen in the Remote User Interface for a description of the configuration error.
Node Offline (LED4)	The Node Offline LED will flash once on power up and flash once 15 seconds after power up. If the Node Offline LED stays on solid, a Node Offline condition has occurred.
RUN (PIO)	The RUN LED will start flashing 20 seconds after power indicating normal operation. The FS-QS-1011-XXXX will be able to access FS-GUI once this LED starts flashing.
PIC RUN (LED5)	The PIC RUN LED will flash indicating normal operation.
PIC ERR (LED6)	The PIC ERR LED will go on solid indicating there is a PIC error.

Light	Description
LON-TX LED	On normal operation of FS-QS-1011-XXXX, the TX LED will flash when a message is sent on the Lon port of the QuickServer.
LON-RX LED	On normal operation of FS-QS-1011-XXXX, the RX LED will flash when a message is received on the Lon port of the QuickServer.
LON-SRV LED (next to Lon port)	The LON-SRV LED will flash if the FS-QS-1011-XXXX is configured for implicit addressing and not commissioned. LED will be off if the FS-QS-1011-XXXX is configured for implicit addressing and commissioned or if it is configured for explicit addressing.
LED 7	Not used
LED 8	Not used

Appendix D.3. QuickServer FS-QS-101X DCC

Driver	Code
BACnet/IP – BACnet MS/TP	0285
BACnet/IP – LonWorks	0131
JCI Metasys N2 – LonWorks	0097
JCI Metasys N2– BACnet MS/TP	0309
JCI Metasys N2– BACnet/IP	0122
Modbus RTU – BACnet MS/TP	0367
Modbus RTU – BACnet/IP	0104
Modbus RTU – JCI Metasys N2	0038
Modbus RTU – LonWorks	0085
Modbus TCP – BACnet/IP	0237
Modbus TCP – LonWorks	0154
Modbus TCP – BACnet MS/TP	0419
Modbus TCP – JCI Metasys N2	0117
SNMP – BACnet/IP	0333
SNMP – LonWorks	0337
SNMP – JCI Metasys N2	0150
Add BACnet MS/TP - LonWorks	0345

Appendix D.4. Compliance with UL Regulations

For UL compliance, the following instructions must be met when operating the QuickServer.

- The units shall be powered by listed LPS or Class 2 power supply suited to the expected operating temperature range.
- The interconnecting power connector and power cable shall:
 - Comply with local electrical code.
 - Be suited to the expected operating temperature range.
 - Meet the current and voltage rating for the QuickServer/Net
 - Furthermore, the interconnecting power cable shall:
 - Be of length not exceeding 3.05m (118.3")

- Be constructed of materials rated VW-1 or FT-1 or better.
 - If the unit is to be installed in an operating environment with a temperature above 65 °C, it should be installed in a Restricted Access Area requiring a key or a special tool to gain access
 - This device must not be connected to a LAN segment with outdoor wiring.

Appendix D.5. Address DIP Switch Settings

Address	A0	A1	A2	A3	A4	A5	A6	A7
0	Off	Off	Off	Off	Off	Off	Off	Off
1	On	Off	Off	Off	Off	Off	Off	Off
2	Off	On	Off	Off	Off	Off	Off	Off
3	On	On	Off	Off	Off	Off	Off	Off
4	Off	Off	On	Off	Off	Off	Off	Off
5	On	Off	On	Off	Off	Off	Off	Off
6	Off	On	On	Off	Off	Off	Off	Off
7	On	On	On	Off	Off	Off	Off	Off
8	Off	Off	Off	On	Off	Off	Off	Off
9	On	Off	Off	On	Off	Off	Off	Off
10	Off	On	Off	On	Off	Off	Off	Off
11	On	On	Off	On	Off	Off	Off	Off
12	Off	Off	On	On	Off	Off	Off	Off
13	On	Off	On	On	Off	Off	Off	Off
14	Off	On	On	On	Off	Off	Off	Off
15	On	On	On	On	Off	Off	Off	Off
16	Off	Off	Off	Off	On	Off	Off	Off
17	On	Off	Off	Off	On	Off	Off	Off
18	Off	On	Off	Off	On	Off	Off	Off
19	On	On	Off	Off	On	Off	Off	Off
20	Off	Off	On	Off	On	Off	Off	Off
21	On	Off	On	Off	On	Off	Off	Off
22	Off	On	On	Off	On	Off	Off	Off
23	On	On	On	Off	On	Off	Off	Off
24	Off	Off	Off	On	On	Off	Off	Off
25	On	Off	Off	On	On	Off	Off	Off
26	Off	On	Off	On	On	Off	Off	Off
27	On	On	Off	On	On	Off	Off	Off
28	Off	Off	On	On	On	Off	Off	Off
29	On	Off	On	On	On	Off	Off	Off
30	Off	On	On	On	On	Off	Off	Off
31	On	On	On	On	On	Off	Off	Off
32	Off	Off	Off	Off	Off	On	Off	Off
33	On	Off	Off	Off	Off	On	Off	Off
34	Off	On	Off	Off	Off	On	Off	Off
35	On	On	Off	Off	Off	On	Off	Off
36	Off	Off	On	Off	Off	On	Off	Off
37	On	Off	On	Off	Off	On	Off	Off

Address	A0	A1	A2	A3	A4	A5	A6	A7
38	Off	On	On	Off	Off	On	Off	Off
39	On	On	On	Off	Off	On	Off	Off
40	Off	Off	Off	On	Off	On	Off	Off
41	On	Off	Off	On	Off	On	Off	Off
42	Off	On	Off	On	Off	On	Off	Off
43	On	On	Off	On	Off	On	Off	Off
44	Off	Off	On	On	Off	On	Off	Off
45	On	Off	On	On	Off	On	Off	Off
46	Off	On	On	On	Off	On	Off	Off
47	On	On	On	On	Off	On	Off	Off
48	Off	Off	Off	Off	On	On	Off	Off
49	On	Off	Off	Off	On	On	Off	Off
50	Off	On	Off	Off	On	On	Off	Off
51	On	On	Off	Off	On	On	Off	Off
52	Off	Off	On	Off	On	On	Off	Off
53	On	Off	On	Off	On	On	Off	Off
54	Off	On	On	Off	On	On	Off	Off
55	On	On	On	Off	On	On	Off	Off
56	Off	Off	Off	On	On	On	Off	Off
57	On	Off	Off	On	On	On	Off	Off
58	Off	On	Off	On	On	On	Off	Off
59	On	On	Off	On	On	On	Off	Off
60	Off	Off	On	On	On	On	Off	Off
61	On	Off	On	On	On	On	Off	Off
62	Off	On	On	On	On	On	Off	Off
63	On	On	On	On	On	On	Off	Off
64	Off	Off	Off	Off	Off	Off	On	Off
65	On	Off	Off	Off	Off	Off	On	Off
66	Off	On	Off	Off	Off	Off	On	Off
67	On	On	Off	Off	Off	Off	On	Off
68	Off	Off	On	Off	Off	Off	On	Off
69	On	Off	On	Off	Off	Off	On	Off
70	Off	On	On	Off	Off	Off	On	Off
71	On	On	On	Off	Off	Off	On	Off
72	Off	Off	Off	On	Off	Off	On	Off
73	On	Off	Off	On	Off	Off	On	Off
74	Off	On	Off	On	Off	Off	On	Off
75	On	On	Off	On	Off	Off	On	Off
76	Off	Off	On	On	Off	Off	On	Off
77	On	Off	On	On	Off	Off	On	Off
78	Off	On	On	On	Off	Off	On	Off
79	On	On	On	On	Off	Off	On	Off
80	Off	Off	Off	Off	On	Off	On	Off
81	On	Off	Off	Off	On	Off	On	Off
82	Off	On	Off	Off	On	Off	On	Off

Address	A0	A1	A2	A3	A4	A5	A6	A7
83	On	On	Off	Off	On	Off	On	Off
84	Off	Off	On	Off	On	Off	On	Off
85	On	Off	On	Off	On	Off	On	Off
86	Off	On	On	Off	On	Off	On	Off
87	On	On	On	Off	On	Off	On	Off
88	Off	Off	Off	On	On	Off	On	Off
89	On	Off	Off	On	On	Off	On	Off
90	Off	On	Off	On	On	Off	On	Off
91	On	On	Off	On	On	Off	On	Off
92	Off	Off	On	On	On	Off	On	Off
93	On	Off	On	On	On	Off	On	Off
94	Off	On	On	On	On	Off	On	Off
95	On	On	On	On	On	Off	On	Off
96	Off	Off	Off	Off	Off	On	On	Off
97	On	Off	Off	Off	Off	On	On	Off
98	Off	On	Off	Off	Off	On	On	Off
99	On	On	Off	Off	Off	On	On	Off
100	Off	Off	On	Off	Off	On	On	Off
101	On	Off	On	Off	Off	On	On	Off
102	Off	On	On	Off	Off	On	On	Off
103	On	On	On	Off	Off	On	On	Off
104	Off	Off	Off	On	Off	On	On	Off
105	On	Off	Off	On	Off	On	On	Off
106	Off	On	Off	On	Off	On	On	Off
107	On	On	Off	On	Off	On	On	Off
108	Off	Off	On	On	Off	On	On	Off
109	On	Off	On	On	Off	On	On	Off
110	Off	On	On	On	Off	On	On	Off
111	On	On	On	On	Off	On	On	Off
112	Off	Off	Off	Off	On	On	On	Off
113	On	Off	Off	Off	On	On	On	Off
114	Off	On	Off	Off	On	On	On	Off
115	On	On	Off	Off	On	On	On	Off
116	Off	Off	On	Off	On	On	On	Off
117	On	Off	On	Off	On	On	On	Off
118	Off	On	On	Off	On	On	On	Off
119	On	On	On	Off	On	On	On	Off
120	Off	Off	Off	On	On	On	On	Off
121	On	Off	Off	On	On	On	On	Off
122	Off	On	Off	On	On	On	On	Off
123	On	On	Off	On	On	On	On	Off
124	Off	Off	On	On	On	On	On	Off
125	On	Off	On	On	On	On	On	Off
126	Off	On	On	On	On	On	On	Off
127	On	On	On	On	On	On	On	Off

Address	A0	A1	A2	A3	A4	A5	A6	A7
128	Off	Off	Off	Off	Off	Off	Off	On
129	On	Off	Off	Off	Off	Off	Off	On
130	Off	On	Off	Off	Off	Off	Off	On
131	On	On	Off	Off	Off	Off	Off	On
132	Off	Off	On	Off	Off	Off	Off	On
133	On	Off	On	Off	Off	Off	Off	On
134	Off	On	On	Off	Off	Off	Off	On
135	On	On	On	Off	Off	Off	Off	On
136	Off	Off	Off	On	Off	Off	Off	On
137	On	Off	Off	On	Off	Off	Off	On
138	Off	On	Off	On	Off	Off	Off	On
139	On	On	Off	On	Off	Off	Off	On
140	Off	Off	On	On	Off	Off	Off	On
141	On	Off	On	On	Off	Off	Off	On
142	Off	On	On	On	Off	Off	Off	On
143	On	On	On	On	Off	Off	Off	On
144	Off	Off	Off	Off	On	Off	Off	On
145	On	Off	Off	Off	On	Off	Off	On
146	Off	On	Off	Off	On	Off	Off	On
147	On	On	Off	Off	On	Off	Off	On
148	Off	Off	On	Off	On	Off	Off	On
149	On	Off	On	Off	On	Off	Off	On
150	Off	On	On	Off	On	Off	Off	On
151	On	On	On	Off	On	Off	Off	On
152	Off	Off	Off	On	On	Off	Off	On
153	On	Off	Off	On	On	Off	Off	On
154	Off	On	Off	On	On	Off	Off	On
155	On	On	Off	On	On	Off	Off	On
156	Off	Off	On	On	On	Off	Off	On
157	On	Off	On	On	On	Off	Off	On
158	Off	On	On	On	On	Off	Off	On
159	On	On	On	On	On	Off	Off	On
160	Off	Off	Off	Off	Off	On	Off	On
161	On	Off	Off	Off	Off	On	Off	On
162	Off	On	Off	Off	Off	On	Off	On
163	On	On	Off	Off	Off	On	Off	On
164	Off	Off	On	Off	Off	On	Off	On
165	On	Off	On	Off	Off	On	Off	On
166	Off	On	On	Off	Off	On	Off	On
167	On	On	On	Off	Off	On	Off	On
168	Off	Off	Off	On	Off	On	Off	On
169	On	Off	Off	On	Off	On	Off	On
170	Off	On	Off	On	Off	On	Off	On
171	On	On	Off	On	Off	On	Off	On
172	Off	Off	On	On	Off	On	Off	On

Address	A0	A1	A2	A3	A4	A5	A6	A7
173	On	Off	On	On	Off	On	Off	On
174	Off	On	On	On	Off	On	Off	On
175	On	On	On	On	Off	On	Off	On
176	Off	Off	Off	Off	On	On	Off	On
177	On	Off	Off	Off	On	On	Off	On
178	Off	On	Off	Off	On	On	Off	On
179	On	On	Off	Off	On	On	Off	On
180	Off	Off	On	Off	On	On	Off	On
181	On	Off	On	Off	On	On	Off	On
182	Off	On	On	Off	On	On	Off	On
183	On	On	On	Off	On	On	Off	On
184	Off	Off	Off	On	On	On	Off	On
185	On	Off	Off	On	On	On	Off	On
186	Off	On	Off	On	On	On	Off	On
187	On	On	Off	On	On	On	Off	On
188	Off	Off	On	On	On	On	Off	On
189	On	Off	On	On	On	On	Off	On
190	Off	On	On	On	On	On	Off	On
191	On	On	On	On	On	On	Off	On
192	Off	Off	Off	Off	Off	Off	On	On
193	On	Off	Off	Off	Off	Off	On	On
194	Off	On	Off	Off	Off	Off	On	On
195	On	On	Off	Off	Off	Off	On	On
196	Off	Off	On	Off	Off	Off	On	On
197	On	Off	On	Off	Off	Off	On	On
198	Off	On	On	Off	Off	Off	On	On
199	On	On	On	Off	Off	Off	On	On
200	Off	Off	Off	On	Off	Off	On	On
201	On	Off	Off	On	Off	Off	On	On
202	Off	On	Off	On	Off	Off	On	On
203	On	On	Off	On	Off	Off	On	On
204	Off	Off	On	On	Off	Off	On	On
205	On	Off	On	On	Off	Off	On	On
206	Off	On	On	On	Off	Off	On	On
207	On	On	On	On	Off	Off	On	On
208	Off	Off	Off	Off	On	Off	On	On
209	On	Off	Off	Off	On	Off	On	On
210	Off	On	Off	Off	On	Off	On	On
211	On	On	Off	Off	On	Off	On	On
212	Off	Off	On	Off	On	Off	On	On
213	On	Off	On	Off	On	Off	On	On
214	Off	On	On	Off	On	Off	On	On
215	On	On	On	Off	On	Off	On	On
216	Off	Off	Off	On	On	Off	On	On
217	On	Off	Off	On	On	Off	On	On

Address	A0	A1	A2	A3	A4	A5	A6	A7
218	Off	On	Off	On	On	Off	On	On
219	On	On	Off	On	On	Off	On	On
220	Off	Off	On	On	On	Off	On	On
221	On	Off	On	On	On	Off	On	On
222	Off	On	On	On	On	Off	On	On
223	On	On	On	On	On	Off	On	On
224	Off	Off	Off	Off	Off	On	On	On
225	On	Off	Off	Off	Off	On	On	On
226	Off	On	Off	Off	Off	On	On	On
227	On	On	Off	Off	Off	On	On	On
228	Off	Off	On	Off	Off	On	On	On
229	On	Off	On	Off	Off	On	On	On
230	Off	On	On	Off	Off	On	On	On
231	On	On	On	Off	Off	On	On	On
232	Off	Off	Off	On	Off	On	On	On
233	On	Off	Off	On	Off	On	On	On
234	Off	On	Off	On	Off	On	On	On
235	On	On	Off	On	Off	On	On	On
236	Off	Off	On	On	Off	On	On	On
237	On	Off	On	On	Off	On	On	On
238	Off	On	On	On	Off	On	On	On
239	On	On	On	On	Off	On	On	On
240	Off	Off	Off	Off	On	On	On	On
241	On	Off	Off	Off	On	On	On	On
242	Off	On	Off	Off	On	On	On	On
243	On	On	Off	Off	On	On	On	On
244	Off	Off	On	Off	On	On	On	On
245	On	Off	On	Off	On	On	On	On
246	Off	On	On	Off	On	On	On	On
247	On	On	On	Off	On	On	On	On
248	Off	Off	Off	On	On	On	On	On
249	On	Off	Off	On	On	On	On	On
250	Off	On	Off	On	On	On	On	On
251	On	On	Off	On	On	On	On	On
252	Off	Off	On	On	On	On	On	On
253	On	Off	On	On	On	On	On	On
254	Off	On	On	On	On	On	On	On
255	On	On	On	On	On	On	On	On

Appendix D.6. Baud DIP Switch Settings

Baud	B0	B1	B2	B3
Auto ⁴	Off	Off	Off	Off
110	On	Off	Off	Off
300	Off	On	Off	Off
600	On	On	Off	Off
1200	Off	Off	On	Off
2400	On	Off	On	Off
4800	Off	On	On	Off
9600	On	On	On	Off
19200	Off	Off	Off	On
20833	On	Off	Off	On
28800	Off	On	Off	On
38400	On	On	Off	On
57600	Off	Off	On	On
76800	On	Off	On	On
115200	Off	On	On	On

Please refer to Section 4.1.1 and Section 4.1.2 for Baud Rate supporting Ports

⁴ Auto-baud is only supported for BACnet MS/TP